

OPERATION & MAINTENANCE MANUAL

FLUIDTROL AQUATIC STRAINER - SW AND RSW SERIES



PAGE NUMBER	CONTENT
2	STRAINER SPECIFICATIONS
3	INSTALLATION INSTRUCTIONS
4	STANDARD SW AND RSW SERIES STRAINER HOUSING DIMENSIONS
5	MAINTENANCE AND OPERATION
6-7	IDENTIFYING YOUR STRAINER
8	COVER AND GASKET ID SHEET
9	COVER SWIVEL INSTRUCTIONS
10-11	PROJECTED PERFORMANCE CURVES
12	WARRANTY

MATERIALS OF CONSTRUCTION

1. STRAINER HOUSING CONSTRUCTION

FPT utilizes a composite / laminate construction for strainer bodies to provide structural strength. Corrosion resistance is maintained by wetted surfaces of PVC Type 1 and Vinyl Ester Resin. All Strainers are rated for 50 PSI at 73 deg F. Higher operating temperatures are allowable based upon the material selection.

2. BASKETS

Baskets are manufactured in heavy gauge stainless T316. Standard perforation pattern is 1/8" holes on 3/16" staggered centers. Different alloys and perforation patterns are sometimes provided.

DESIGN

1. INFLUENT AND EFFLUENT CONNECTIONS

ALL INLETS AND OUTLETS ARE PVC SCH 80 Flanges. Loose rings may be utilized- ANSI b16.5- 150 # Drill.

2. TOPS

Aquatic strainers are machined from casted acrylic- minimum 1" thickness. Fluidtrol Stainless T-Handles/ Swing latch for lid assemblies are provided for lid attachment.

3. PORT CONFIGURATIONS

AS STANDARD, FPT OFFERS AN "IN-LINE" DESIGN FOR BOTH SW AND RSW (ECCENTRIC REDUCING). FOR SPECIAL APPLICATIONS "OFF-SET", " ANGLED OFF-SET" AND "BOOT" MAY HAVE BEEN FABRICATED FOR YOUR SYSTEM. ALL UNITS ARE EQUIPPED WITH A SIDE BOTTOM SIDE DRAIN AS STANDARD- LOCATED ON INLET SIDE OF HOUSING.

PRESSURE DROP

FPT STRAINERS ARE ENGINEERED TO OFFER THE LOWEST PRACTICAL dP (PRESSURE DROP). UTILIZING FULL FLOW PORTS, THE BASKET OPEN AREA AVERAGES 4 TIMES (MINIMUM) THE CROSS SECTIONAL AREA OF THE PIPE. THIS, ON AVERAGE, PROVIDES ADEQUATE PERFORMANCE FOR STRAINERS INSTALLED IN LINES THAT OPERATE UP TO 6 FPS FLOW VELOCITY. PRESSURE DROP THROUGH STRAINER IS DETERMINED BY THE LINE SIZE FLOW RATE, SPECIFIC GRAVITY, AND OPEN AREA SURFACE OF THE BASKET. individual dP VS FOULING CHARTS ARE AVAILABLE- REFER TO PAGES 10-11. FOR CUSTOMIZED PERFORMANCE REPORTS, PLEASE CONSULT FACTORY.

OPERATION

The function of a basket strainer is to collect particles, lint and other items. For pool applications, they are typically installed on the suction side of the pump to protect the impeller from damage or vane fouling, both of which will reduce turnover. The degree of filtering is dependent on the maximum size opening of the perforated material the basket is made of. Fluidtrol (FPT) baskets come with standard perforations of 1/8" holes on 3/16" staggered centers and are fabricated entirely Stainless T316. Routinely, baskets are provided with alternative perforation sizes and finer filtration may be utilized with the addition of a mesh liner to the basket. The mesh size number states the number of openings per square inch.

Fouled strainer baskets will reduce water flow, increasing vacuum on pump suction. This is a potential cause for pump cavitation, pump seal failure or air in-leakage.

A pressure drop is induced across the strainer. As the strainer fouls, the pressure drop increases. Clean strainers cause the least amount of pressure drop. Pressure drop profiles for standard sized strainers are provided on the last two pages of this manual.

Basket cleaning is the primary maintenance performed on a basket strainer. Frequency of cleanings is system dependent and usually varies with loading or seasons (for outdoor pools).



INSTALLATION

Prior to connecting this strainer or reducer to your piping system, check the following:

1. Directional flow.
2. Compatibility of connecting piping to the inlet and outlet connections provided on the strainer or reducer
3. Piping supports. Be sure that the

strainer is **NOT SUPPORTING ANY PIPING OR TANKS** as this can cause excessive stresses in the strainer body.

We recommend avoiding suspended strainer applications. Please support strainer bodies at the bottom of the vertical housing.

Flanged end connectors are standard with the Fluidtrol AQUATIC strainers and reducers. The proper installation technique is outlined below.*

FLANGED CONNECTIONS

A. 1/8" thick soft full face gaskets are preferred for use with plastic flanges

B. Make sure that all the bolt holes of the mating flanges match up with the strainer flange bolt holes. The flanges on the strainers and reducers are lined up such that the bolt holes straddle the vertical centerline. Strainer flanges up to 12" are loose ring flanges, so rotating is possible if existing plumbing is not aligned properly.

C. Insert all bolts only after strainer is in its final position-- see "H" to the right for more info.

D. Make sure that the faces of the mating flanges are not separated by more than 1/16" after gasket insertion. If there is a larger gap, it may be necessary to insert a spacer ring between the two flanges.

E. The bolts on the plastic flanges should be tightened by pulling down the nuts diametrically opposite each other using a torque wrench- see FIG 1. Complete tightening should be accomplished in stages and the final torque values in the following table should be followed for the various sizes of flanges. Uniform stress across the flange will help prevent leaky gaskets. Refer to **TABLE 1** for recommended torques.

F. Required bolt sizes are given in **TABLE 2**. These are based on average SCH 80 PVC Flanges.

G. The drain and lid vent should be plumbed for use. Drain fittings are typically hard-piped to a suitable drain. The lid vent is typically plumbed with flexible hose to allow for lid removal. Quick disconnects (i.e. Cam-Lock) are also a good practice for the lid vent line. Valves should be affixed to both positions

H. Strainer positioning is very important when tightening the flange bolts. Fluidtrol strainer and reducer flange flush tolerance is +/- 0.5 degrees. Fitting flanges must be flush with piping flanges prior to tightening. Please do not attempt to pull the strainer housing into an upright, flush-flange position by tightening the flange bolts. This routinely results in flange hub cracking and is considered installation error, which possibly will void the warranty on the strainer repair.

I. All Threaded Fittings (NPT Drains/Pressure Taps) are to be tightened the standard torque- hand tight plus 1 turn. Over tightening can result in broken fittings.

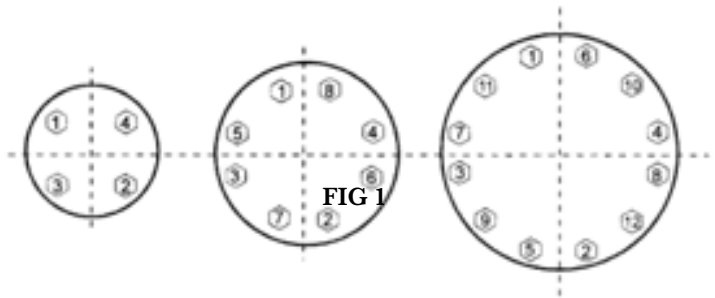

Table 1

Flange Size	Torque Value
3" and 4"	20-30 ft lbs
6" and 8"	30-50 ft lbs
10" and 12"	53-75 ft lbs

Table 2

Flange Size	Bolt Size
3"	5/8-11 x 3 5/8"
4"	5/8-11 x 3 3/4"
6"	3/4-10 x 4 3/8"
8"	3/4-10 x 4 3/8"
10"	7/8-9 x 4 1/2"
12"	7/8-9 x 4 5/8"

Fluidtrol does not recommend the practice of drilling/tapping into our dual laminate housings and reducers for pressure taps. This may result in voided warranty. Please contact factory if pressure tap is required.

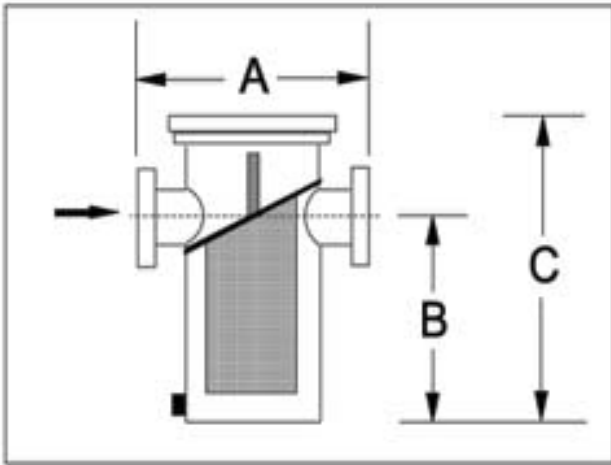

SW Series Strainer			
Strainer Size	A	B	C
3"	11"	10-1/2"	18"
4"	13-3/4"	11-5/8"	22"
5"	17"	16"	25"
6"	18"	16"	25"
8"	20"	21-1/2"	33"
10"	22"	23"	37"
12"	27-1/2"	31-5/8"	45-1/2"
14"	35"	32-1/2"	47"

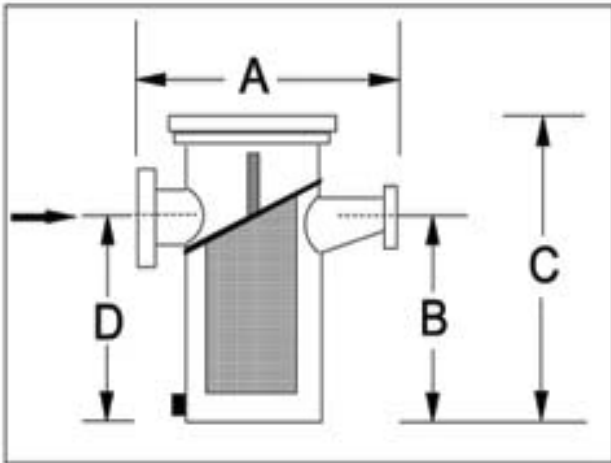

RSW Series Reducing Strainer				
Strainer Size	A	B	C	D
4" x 3"	15-3/4"	12-1/8"	22"	11-5/8"
6" x 3"	20-3/4"	17-1/2"	25"	16"
6" x 4"	21"	17"	25"	16"
6" x 5"	23"	16-1/2"	25"	16"
8" x 3"	25-3/4"	24"	33"	21-1/2"
8" x 4"	26-1/8"	23-1/2"	33"	21-1/2"
8" x 5"	28"	23"	33"	21-1/2"
8" x 6"	28"	22-1/2"	33"	21-1/2"
10" x 4"	29-5/8"	26"	37"	23"
10" x 5"	29-5/8"	25-1/2"	37"	23"
10" x 6"	29-5/8"	25"	37"	23"
10" x 8"	29-1/2"	24"	37"	23"
12" x 6"	33-1/8"	34-5/8"	45-1/2"	31-5/8"
12" x 8"	32-3/4"	33-5/8"	45-1/2"	31-5/8"
12" x 10"	32-3/4"	32-5/8"	45-1/2"	31-5/8"

MAINTENANCE

When cleaning becomes necessary the guidelines listed below should be followed. NEVER ATTEMPT TO OPEN A STRAINER WHILE UNDER PRESSURE. Attempting to do so can result in a catastrophic failure causing personal injury and voiding warranty. Strainer basket cleaning is completely system dependent and should be performed as any preventative maintenance task once the frequency has been determined. Fluidtrol recommends cleaning the basket prior to the observance of a 3 psid pressure drop across the vessel. This is calculated by the difference between the gauge pressure just upstream and the gauge pressure just downstream of the strainer. After the initial cleaning of the system, begin to monitor the pressure drop every hour to determine the cleaning frequency. Using the pressure drop charts on the pages at the end of this manual can provide some assistance, but generating data on your particular system will be necessary to determine proper cleaning frequency.

1. Stop flow through strainer. For simplex units this requires stopping the process flow. For duplex units, the process flow must be redirected into the secondary housing by means of the valves/ valve mechanism.

2. Remove pressure from housing. The drain plug at the base of the strainer or vent valve on the lid can be used for this purpose if other pressure relief methods are unavailable. NEVER remove the lid prior to depressurizing.

3. Remove lid. SW and RSW Strainers utilize T-Handles/ Swing Latch lid assembly. Loosen the I-bolts of the lid by alternating between diametrically opposite bolts. Once all bolts are loose, swing the T-Handles to the side. If you chose to utilize your swivel lid retaining bracket- swivel the cover to this location of housing and it will be held in place.

4. Remove and clean basket. Various methods of cleaning are utilized, depending on the material in the basket and it's tenacity to the perforated surface. It is common to have 2 baskets to allow for the fouled basket to be quickly replaced with a clean basket. This allows for the minimum flow interruption and for the dirty basket to be cleaned as convenient at some point prior to the next basket change.

5. Refill vessel with process fluid. Reducing the air pocket at the top of the housing is critical for minimizing the potential to air lock the system pump. If possible, fill the vessel with process/pool water to approximately 1" from the lid gasket.

6. Replace lid and secure. Tighten as tight as necessary to avoid water drips through the gasket and to avoid air in leakage due to vacuum. Follow an alternating pattern when tightening- just as tightening lug nuts on a tire or flange bolts.

7. Return to service and vent. SLOWLY OPEN NECESSARY VALVES TO PUT THE STRAINER ON LINE. After the strainer is returned to service- it may be necessary to bleed off any remaining air trapped at the top of the housing. This is done with the ½" vent on the lid that the strainer is supplied with. The strainer housings are common air traps for the system, so routine bleeding at this location may help efforts to minimize air in system.



Fluidtrol Aquatic Strainers

SPARE PARTS AND TECHNICAL SUPPORT

Your strainers are shipped with a 5-7 digit serial number on the permanent equipment tag. This number should be preserved in the event technical support or parts are required. Many of the parts will be commercially available from a local plumbing distributor, but items such as the basket and special gaskets will require you to contact your Fluidtrol dealer.

You can contact Fluidtrol Process Technologies, Inc. at 888-551-0511 for support at any time during installation, commission or operation of your strainer. Unlimited technical support is part of the product that you have purchased.

IMPORTANT STRAINER/SYSTEM DATA

In the event troubleshooting is required- it is optimum to have as much system/ equipment data collected as possible. The below lists represent most of the variables that may be relevant.

FLUID CHARACTERISTICS

Composition
Operating Temperature F
Operating Pressure
Viscosity centipoise
Minimum Size To Filter mesh micron inch mm
Allowable Pressure Drop PSI (clean basket)
Flow Rate GPM

STRAINER CHARACTERISTICS

Type of Strainer
Size
Design Flow Rate GPM
Design Pressure PSI
Max Temperature
Max Pressure
Housing Material
Gasket Material
Basket Perforation
Basket Material
Liner Rating
Liner Material
Drain Size/Type
End Connections
Vent Size/Type
Pressure Taps
Model Number
Date of Manufacture
Serial Number

AQUATIC SERIES STRAINER PART NUMBER CODE

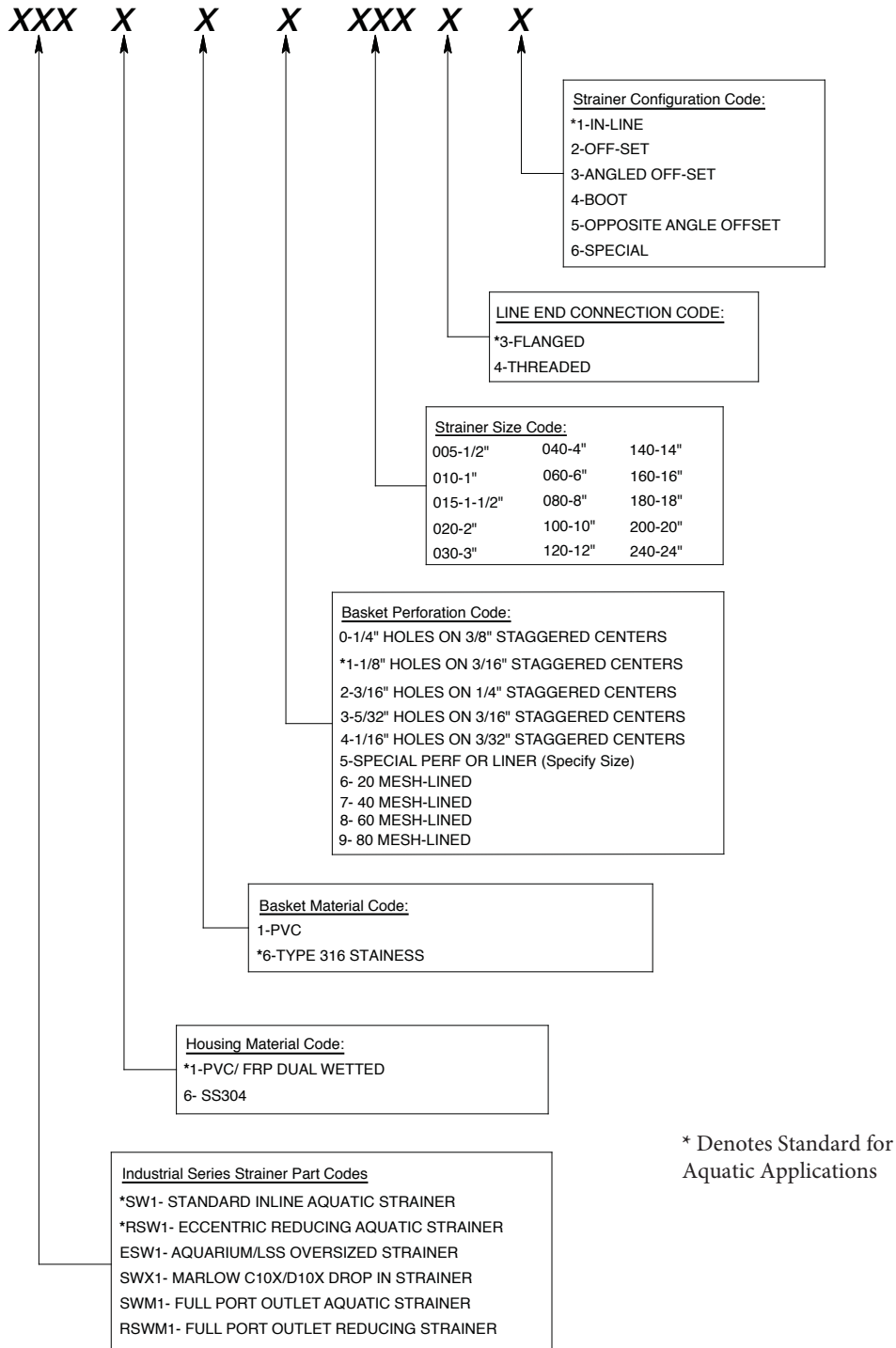

TO IDENTIFY YOUR PARTICULAR STRAINER, USE THE ABOVE KEY TO DETERMINE CORRECT STRAINER MODEL. STRAINER MODEL IS ALSO PROVIDED ON THE EQUIPMENT IDENTIFICATION TAG AFFIXED TO THE STRAINER HOUSING.

ACRYLIC COVER / GASKET ID GUIDE



STRAINER INLET FLANGE	ACRYLIC COVER OD	ACRYLIC COVER THICKNESS	QTY OF FASTENERS	FASTENER BOLT CIRCLE DIAMETER	FASTENER SLOT DISTANCE	1/2" NPT VENT POSITION	STRAINER MFG DATE	GASKET TYPE	GASKET DIMENSIONS ID / OD (DASH NO)	ACRYLIC COVER PART NUMBER	GASKET PART NUMBER	Notes
3"	9.5"	1"	6	8.3125	7.8125	Center	1991 or after	Flat	5.75" / 7.25"	1-030-5105A	1-030-5105D	Original SW INTERCHANGEABLE
	10.25"	1"	6	8.875	8.375	Center	2009-2015	1/4" O-Ring	2-442 (7.25/7.75")	1-030-5105AN	1-030-5105O	
	10.392"	1"	6	8.892	8.392	Side	2015 or after	1/4" O-Ring	-441 (7/7.5")	1-030-5105AN	1-030-5105ON	
4"	11.5"	1"	6	10.25	9.75	Center	1991 or after	Flat	7.5" / 9.25"	1-040-5105A	1-040-5105D	Original SW SWC NEW SW
	12.375"	1"	6	11.25	10.75	Center	2009-2015	1/4" O-Ring	2-448 (9.5/10")	1-040-5105AC	1-040-5105O	
	12.392"	1"	6	10.892	10.392	Side	2015 or after	1/4" O-Ring	-447 (9/9.5")	1-040-5105AN	1-040-5105ON	
6"	13.625"	1"	6	12.4375	11.9375	Center	1991 or after	Flat	9.25" / 11.75"	1-060-5105A	1-060-5105D	Original SW SWC NEW SW
	14.75"	1"	6	13.5	13	Center	2009-2015	1/4" O-Ring	2-452 (11.5/12")	1-060-5105AC	1-060-5105O	
	14.517"	1"	6	13.017	12.517	Side	2015 or after	1/4" O-Ring	-451 (11/11.5")	1-060-5105AN	1-060-5105ON	
8"	15.625"	1"	6	14.4375	13.9375	Center	1991 or after	Flat	11" / 13.5"	1-080-5105A	1-080-5105D	Original SW SWC (uses 10" Original SW) NEW SW
	16.867"	1"	6	15.6	15.1	Center	2009-2015	1/4" O-Ring	2-456 (13.5/14")	1-100-5105A	1-080-5105O	
	16.517"	1"	6	15.017	14.517	Side	2015 or after	1/4" O-Ring	-455 (13/13.5")	1-080-5105AN	1-060-5105ON	
10"	16.867"	1"	6	15.6	15.1	Center	1991 or after	Flat	12.25" / 15"	1-100-5105A	1-100-5105D	Original SW SWC (uses 12" Original SW) NEW SW
	19"	1.25"	8	17.75	17.25	Center	2009-2015	1/4" O-Ring	2-459 (15/15.5")	1-120-5105A	1-100-5105O	
	18.017"	1"	6	16.517	16.017	Side	2015 or after	1/4" O-Ring	-458 (14.5/15")	1-100-5105AN	1-060-5105ON	
12"	19"	1.25"	8	17.75	17.25	Center	1991 or after	Flat	14.75" / 16.75"	1-120-5105A	1-120-5105D	Original SW SWC (uses 14" Original SW) NEW SW
	20.875"	1.25"	12	19.75	19.25	Center	2009-2015	1/4" O-Ring	2-464 (17.5/18")	1-140-5105A	1-120-5105O	
	20.017"	1.25"	8	18.517	18.017	Side	2015 or after	1/4" O-Ring	-462 (16.5/17")	1-100-5105AN	1-060-5105ON	
14"	20.875"	1.5"	12	19.75	19.25	Center	1991 or after	Flat	16.75" / 18.75"	1-140-5105A	1-140-5105D	Original SW SWC (uses 16" Original SW) NEW SW
	22.625"	1.5"	12	21.68	21.18	Center	2009-2015	1/4" O-Ring	2-467 (19-19.5")	1-160-5105A	1-140-5105O	
	22.267"	1.25"	12	20.767	20.267	Side	2015 or after	1/4" O-Ring	-466 (18.5-19")	1-140-5105AN	1-140-5105ON	

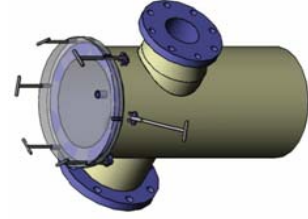
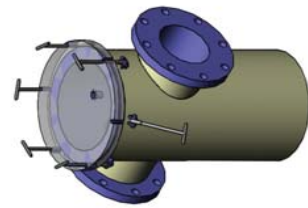
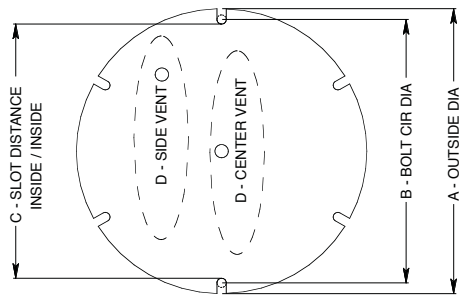

ORIGINAL SW- UTILIZES A FLAT GASKET AND MANUFACTURED PRIOR TO 2015 WITH SERIAL NO < 12467
 SWC TYPE- UTILIZES A O-RING GASKET AND MANUFACTURED FROM 2009-2015 (ALSO SWMC MODEL)
 NEW SW- UTILIZES AN O-RING GASKET AND MANUFACTURED DURING AND AFTER 2015

** INCLUDES REDUCING VERSIONS (RSW), SWM

** CONTACT FLUIDTROL IF YOU NEED HELP IDENTIFYING WHICH LID OR GASKET YOU NEED **



Swivel Lid Retaining Bracket Installation/ Operation Guide

Fluidtrol now offers a new feature that allows single hand operation while strainer baskets are being removed and serviced. Newly manufactured aquatic series strainers and some industrial models are being supplied with these machined PVC brackets and associated hardware to serve as resting locations for the cover while strainer housings are open. These kits are universal and will be compatible on all aquatic strainers manufactured after November 2015.

Step One: Identify Location

You will have a minimum of 6 locations to choose from that will be the most convenient location for this retaining bracket. Variables such as which side of strainer you will be servicing from, walkways, other equipment and even right/left handedness will impact your decision. If you decide a different location is better- you will be able to change.



Step Two: Install the Housing O-Ring and Lid Retainer on the Housing SS Bracket of choice.

Your lid and fastener package includes one set of longer hardware for installing the bracket- as shown in picture to the right. Position the wedge-shaped PVC brackets on either side of U-Brackets that hold the I-Bolts to the strainer- along with the I-Bolts. The cover will have slots- except for one single 1/2" dia through-hole. This is the correct lid location for your bracket site.

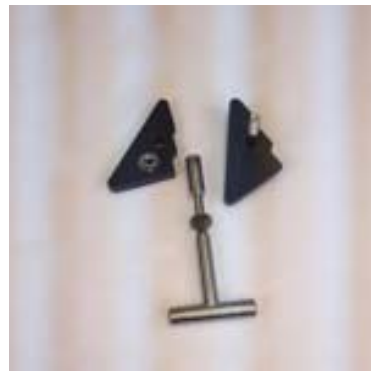

Step Three: Operation

Swing all I-Bolts open except the one that will be used to swivel. The countersink in the lid will allow you to securely retain the acrylic cover. Loosen this location only to take the tension off the O-Ring.



3 " Strainer

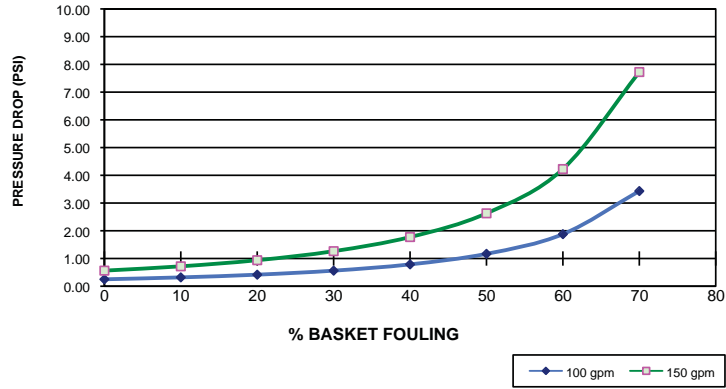

4 " Strainer

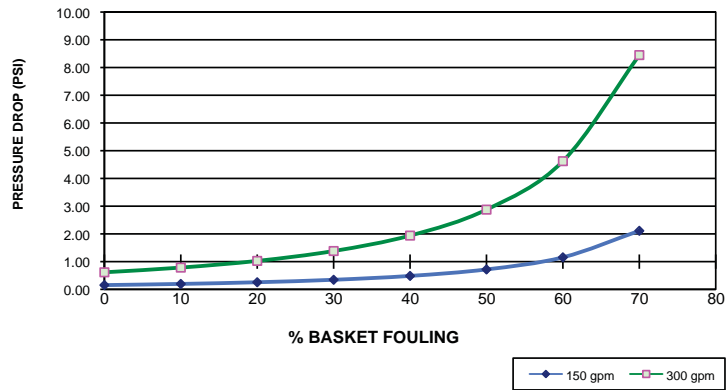

6 " Strainer

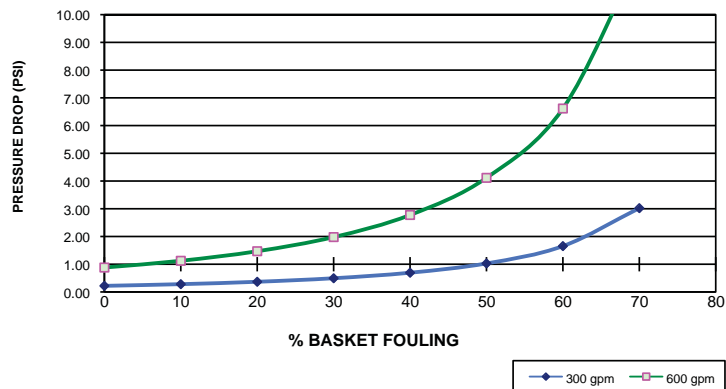

40 % OPEN AREA PERFORATION PATTERN- STANDARD 1/8" OR 1/4"

NOTE: PRESSURE DROP PROFILES DO NOT INCLUDE REDUCERS

8 " Strainer

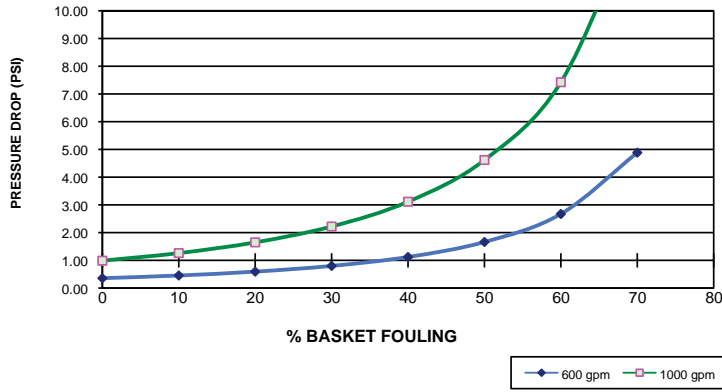

10 " Strainer

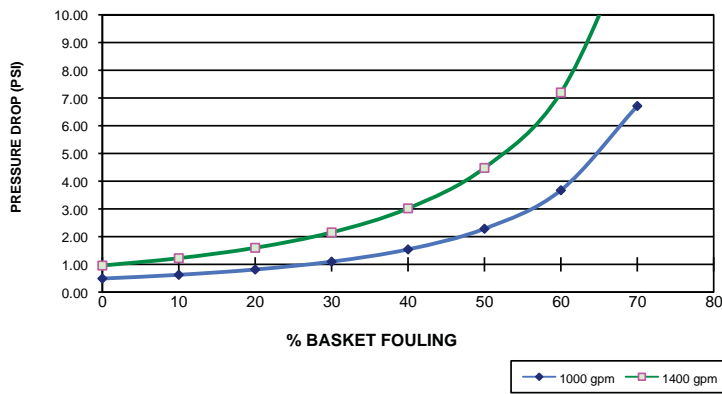

12 " Strainer

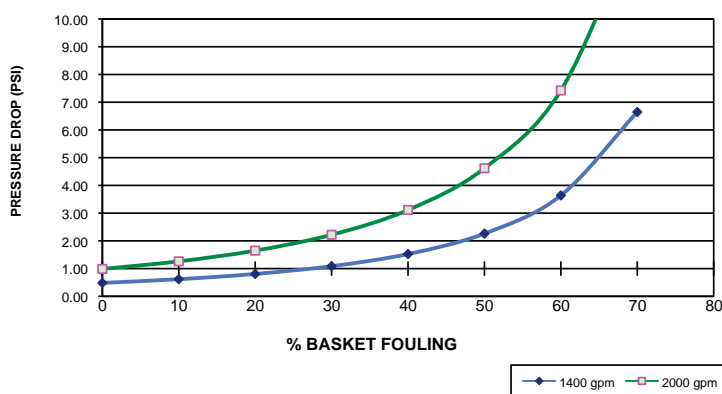

40 % OPEN AREA PERFORATION PATTERN- STANDARD 1/8" OR 1/4"

NOTE: PRESSURE DROP PROFILES DO NOT INCLUDE REDUCERS

WARRANTY

FLUIDTROL PROCESS TECHNOLOGIES, INC. (“SELLER”) warrants that its products will be of the kind and quality described in the Sales Order or Contract and will be free of defects in workmanship or material. Should any failure to conform to this warranty appear within twelve (12) months after the initial date of delivery the Seller will, upon notification and substantiation that the product has been stored, installed and maintained in accordance with the Seller’s recommendation and standard industry practice, correct such defects by suitable repair or replacement at Seller’s expense. Seller shall be given the opportunity to inspect the product. Basket strainers are manufactured to meet specific specifications and no warranty is made where the original configuration is altered or modified for specialized applications or requirements.

THIS WARRANTY IS EXCLUSIVE AND IS IN LIEU OF ANY WARRANTY OF MERCHANTABILITY, FITNESS FOR A PARTICULAR PURPOSE OR OTHER WARRANTY OF QUALITY, WHETHER EXPRESS OR IMPLIED, EXCEPT OF TITLE.

NO WARRANTY IS INCLUDED AGAINST ANY EXPENSE FOR REMOVAL, REINSTALLATION OR OTHER CONSEQUENTIAL DAMAGES ARISING FROM ANY DEFECT.

Correction of non-conformities, in the manner and for the period of time provided above, shall constitute fulfillment of all liabilities of the Seller to the purchase, with respect to, or arising out of, the product, whether based on contract, negligence, strict tort or other legal theory.

The Seller shall not under any circumstances be liable for special or consequential damages such as, but not limited to, damage or loss of property or equipment, loss of profits or revenue, cost of capital, cost of purchased or replacement goods, or claims of customers for service interruptions. The remedies of the purchaser set forth herein are exclusive and the liability of Seller with respect to any contract or anything done in connection therewith, such as the performance or breach there of or from the manufacture, sale, delivery, resale, installation or use of any goods covered by or furnished under contract, whether arising out of contract negligence, strict tort or under any warranty, or otherwise shall not, except as expressly provided herein, exceed the price of the goods upon which such liability is based.